

STEP 3

Secure the Back Panel (E) to the Seat with M8 x 45MM Bolts (I) and Allen Key (J).

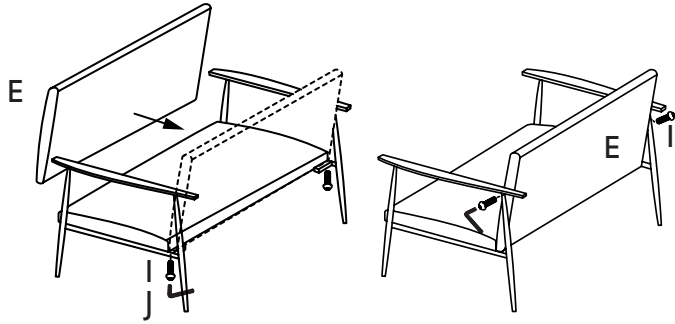

STEP 4

Place the Seat Cushion (F) and Back Cushion (G) on the Chair.

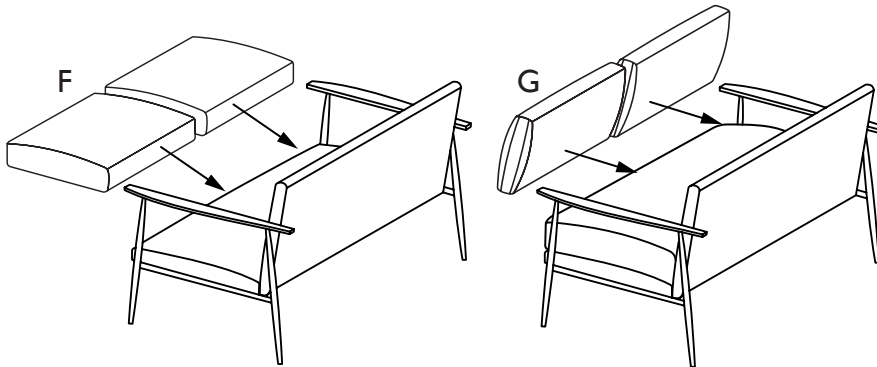

STEP 5

Your Two Seater Chair is now ready for use.

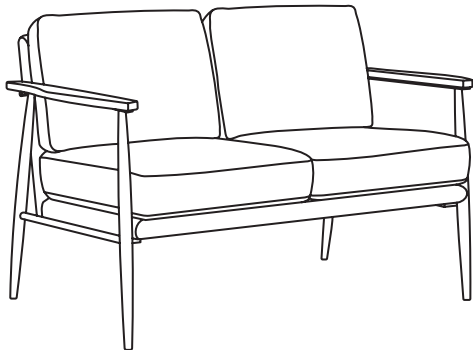

FABRIC CONTENT
MAIN FABRIC 100% POLYESTER
OTHER FABRIC (VISIBLE)
NON-WOVEN FABRIC 100% POLYESTER

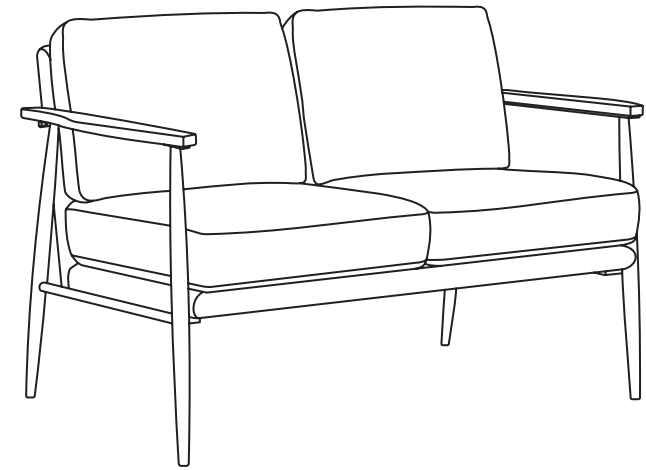

KY469 TWO SEATER CHAIR

Thank you for your purchase. The following care instructions will allow you to make the most of your chair; helping to prolong the look and life of it by preventing wear and damage.

IMPORTANT INFORMATION
PLEASE ENSURE YOU READ THIS LEAFLET BEFORE USING YOUR CHAIR. DO NOT DISCARD OF ANY PACKAGING UNTIL YOU HAVE CHECKED THE PRODUCT THOROUGHLY.

CARING FOR YOUR CHAIR

- Pre-brush fabric with a soft brush and then gently vacuum.
- Plump any accent/removable cushions regularly to prevent them becoming mis-shaped or flat.
- Use a microfibre cloth to remove dust from wooden surfaces.
- In the event of a spill or stain, use specialist upholstery cleaner or cleaning services.









SUNLIGHT AND HEAT DAMAGE

- Avoid contact with direct sunlight. If needed, move items or change their position to avoid the same area being exposed to repeated sunlight/heat.
- Do not place your chair close to fire places and/or radiators.
- Hot objects such as mugs/plates can permanently mark the fabric and wood, avoid placing these on the chair.

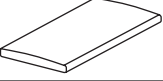
SAFETY WARNINGS

- Do not allow children or pets to climb or jump on the chair or through the arms.
- Avoid contact with sharp objects such as buckles, toys and jewellery as these can easily snag, tear and/or pull the fabric.
- Avoid the risk of entrapment by using the chair as intended; sitting facing forward on the seat.
- Keep small parts away and out of reach of children and pets.

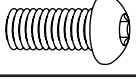
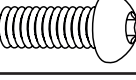
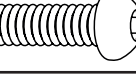
PARTS LIST

IMAGE	DESCRIPTION	PART NO.	QTY
	Arm Rest	A	2
	Left Arm Frame	B	1
	Right Arm Frame	C	1
	Seat Panel	D	1
	Back Panel	E	1
	Seat Cushion	F	2
	Back Cushion	G	2
	M8 x 20MM Bolt	H	6
	M8 x 40MM Bolt	I	10
	M8 x 45MM Bolt	J	2
	Allen Key	K	1

ASSEMBLY INSTRUCTIONS

Unpack your sofa bed and check that all the parts on the Parts List are present - these may be in a zip compartment within the base. If any are missing, please contact the retailer from whom you purchased the product. We would advise having 2 people to assemble this product.

STEP 1

Assemble your chair on a flat, soft surface to prevent any damage. Secure the Arm Rests (A) to the Arm Frames (B&C) using the M8 x 20MM Bolts (H) with the Allen Key (J)

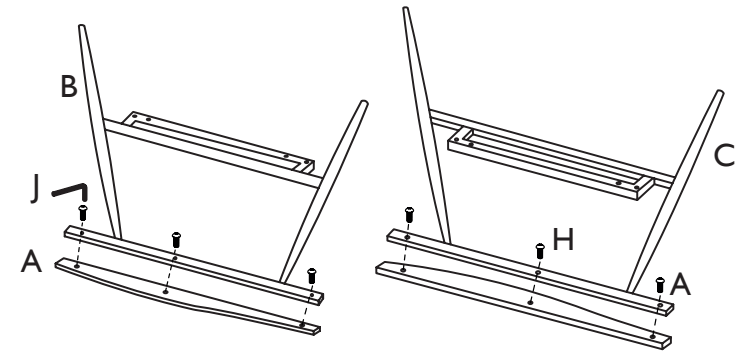

STEP 2

Use the M8 x 45MM Bolts (I) and Allen Key (J) to secure the Arms to the Seat Panel (D).

